

LED Maschinenleuchte

LED machine light



TUBELED_40 Element DC, 1540 mm, 24V DC

Artikel-Nr.: 119610-02
EAN: 4260556624402

Bestell-Nr.:	119610-02
Modell:	TUBELED_40 Element
Bauform:	LED Aufbauleuchte
Leuchtmittel:	SMD LED
Lampenleistung:	~38 W
Lampenlichtstrom:	5670 lm
Lampenlichtausbeute:	145 lm/W
Lichtverteilung:	direkt
Lichtfarbe:	Tageslichtweiß (5200 - 5700K)
Anschlusswert Leuchte:	24V DC \pm 10%
Anschluss Leuchte:	M12 A-kodiert
Schutzart:	IP54
Schutzklasse:	III
Entblendung:	Diffusor, PMMA
Abstrahlwinkel:	100°
Betriebstemperatur:	-30... +70 °C
Farbwiedergabe (Ra):	> 85
Lampenlebensdauer:	> 60.000 h
Material Gehäuse:	Aluminium, Endkappen Kunststoff
Material Abdeckung:	PMMA, gefrostet
Höhe [B] x Breite [C]:	29 mm x 40 mm
Länge [A]:	1540 mm
Gewicht:	1840 g
Bruttogewicht:	2400 g
Risikogruppe (DIN EN 62471):	freie Gruppe
Kennzeichnung:	CE, UKCA
Befestigungszubehör:	optional
Dimmbar:	optional über Zubehör
Gefertigt in:	Deutschland
Besonderheit:	hohtemperaturbeständig

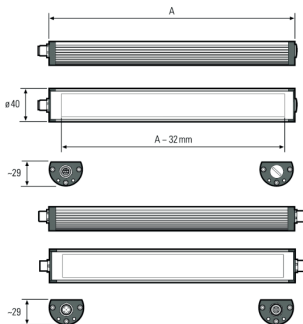

Lampenlebensdauer in Betriebsstunden (L80/B10)

LED Maschinenleuchte
LED machine light



TUBELED_40 Element DC, 1540 mm, 24V DC

Item number: 119610-02
EAN: 4260556624402

Order number: 119610-02
Model: TUBELED_40 Element
Type: LED surface-mounted luminaire
Illuminant: SMD LED
Power consumption: ~38 W
Lamp luminous flux: 5670 lm
Lamp luminous efficiency: 145 lm/W
Light distribution: direct
Light colour: daylight white (5200 - 5700K)
Connected load: 24V DC \pm 10%
Connection (connector): M12 A-type encoded
Degree of protection: IP54
Class of protection: III
Glare-free diffuser sheet for scattered light, PMMA
Beam angle (optics): 100°
Operating temperature: -30... +70 °C
Colour rendering (Ra): > 85
Lamps lifetime: > 60,000 h
Housing material: aluminium, endcaps made of plastics
Cover material: PMMA, frosted
Height [B] x Width [C]: 29 mm x 40 mm
Length [A]: 1540 mm
Weight (net): 1840 g
Gross weight: 2400 g
Risk group (DIN EN 62471): free group
Marking: CE, UKCA
Mounting accessories: optional
Dimmable: via optional accessory
Made in: Germany
Feature: resistant to high temperatures

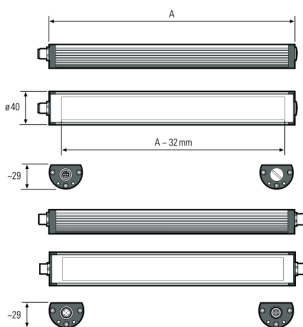

Lamps lifetime in operation hours (L80/B10)