

LED Maschinenleuchte

LED machine light



TUBELED_40 Element DC, 190 mm, 24V DC

Artikel-Nr.: 119010-02
EAN: 4260556624280

Bestell-Nr.:	119010-02
Modell:	TUBELED_40 Element
Bauform:	LED Aufbauleuchte
Leuchtmittel:	SMD LED
Lampenleistung:	~4 W
Lampenlichtstrom:	630 lm
Lampenlichtausbeute:	145 lm/W
Lichtverteilung:	direkt
Lichtfarbe:	Tageslichtweiß (5200 - 5700K)
Anschlusswert Leuchte:	24V DC \pm 10%
Anschluss Leuchte:	M12 A-kodiert
Schutzart:	IP54
Schutzklasse:	III
Entblendung:	Diffusor, PMMA
Abstrahlwinkel:	100°
Betriebstemperatur:	-30... +70 °C
Farbwiedergabe (Ra):	> 85
Lampenlebensdauer:	> 60.000 h
Material Gehäuse:	Aluminium, Endkappen Kunststoff
Material Abdeckung:	PMMA, gefrostet
Höhe [B] x Breite [C]:	29 mm x 40 mm
Länge [A]:	190 mm
Gewicht:	240 g
Bruttogewicht:	450 g
Risikogruppe (DIN EN 62471):	freie Gruppe
Kennzeichnung:	CE, UKCA
Befestigungszubehör:	optional
Dimmbar:	optional über Zubehör
Gefertigt in:	Deutschland
Besonderheit:	hohtemperaturbeständig

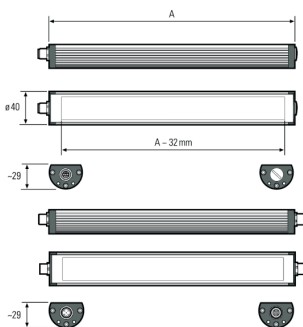

Lampenlebensdauer in Betriebsstunden (L80/B10)

LED Maschinenleuchte
LED machine light



TUBELED_40 Element DC, 190 mm, 24V DC

Item number:	119010-02
EAN:	4260556624280

Order number:	119010-02
Model:	TUBELED_40 Element
Type:	LED surface-mounted luminaire
Illuminant:	SMD LED
Power consumption:	~4 W
Lamp luminous flux:	630 lm
Lamp luminous efficiency:	145 lm/W
Light distribution:	direct
Light colour:	daylight white (5200 - 5700K)
Connected load:	24V DC \pm 10%
Connection (connector):	M12 A-type encoded
Degree of protection:	IP54
Class of protection:	III
Glare-free	diffuser sheet for scattered light, PMMA
Beam angle (optics):	100°
Operating temperature:	-30... +70 °C
Colour rendering (Ra):	> 85
Lamps lifetime:	> 60,000 h
Housing material:	aluminium, endcaps made of plastics
Cover material:	PMMA, frosted
Height [B] x Width [C]:	29 mm x 40 mm
Length [A]:	190 mm
Weight (net):	240 g
Gross weight:	450 g
Risk group (DIN EN 62471):	free group
Marking:	CE, UKCA
Mounting accessories:	optional
Dimmable:	via optional accessory
Made in:	Germany
Feature:	resistant to high temperatures

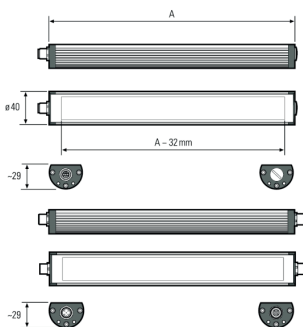

Lamps lifetime in operation hours (L80/B10)