

LED Maschinenleuchte

LED machine light

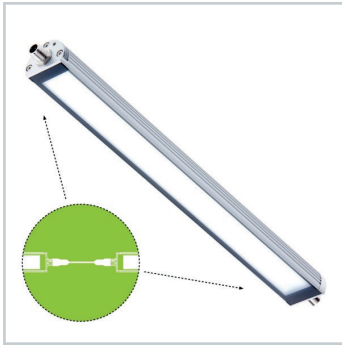

TUBELED_40 II ECO, Länge 280 mm, kaskadierbar

Artikel-Nr.: 118110-12
EAN: 4260556622774

Bestell-Nr.:	118110-12
Modell:	TUBELED_40 II
Bauform:	LED Aufbau Maschinenleuchte
Leuchtmittel:	SMD LED
Lampenleistung:	~6 W
Lampenlichtstrom:	945 lm
Lampenlichtausbeute:	145 lm/W
Lichtverteilung:	Light Forming Technology
Lichtfarbe:	Tageslichtweiß (5200 - 5700K)
Anschlusswert Leuchte:	24V DC \pm 10%
Anschluss Leuchte:	M12 A-kodiert
Schutzart:	IP67/IP69K
Schutzklasse:	III
Entblendung:	Diffusor ESG
Abstrahlwinkel:	100°
Betriebstemperatur:	-30... +70 °C
Farbwiedergabe (Ra):	> 85
Lampenlebensdauer:	> 60.000 h
Material Gehäuse:	Aluminium
Material Abdeckung:	Sicherheitsglas, 4 mm
Höhe [B] x Breite [C]:	29 mm x 40 mm
Länge [A]:	280 mm
Gewicht:	360 g
Bruttogewicht:	550 g
Risikogruppe (DIN EN 62471):	freie Gruppe
Kennzeichnung:	CE, UKCA, ETL Listed (5003526)
Befestigungszubehör:	optional
Dimmbar:	optional über Zubehör
Gefertigt in:	Deutschland
Besonderheit:	hohtemperaturbeständig, kaskadierbar

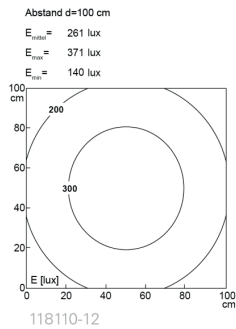

Elektrische Durchgangsverdrahtung (kaskadierbar) bis max. 8 A DC bei ta max. +30 °C (7 A DC bei ta max. +40 °C)
 Lampenlebensdauer in Betriebstunden (L80/B10)

LED Maschinenleuchte
LED machine light

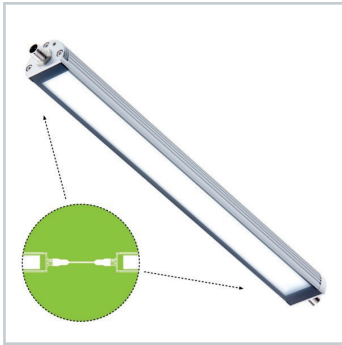

TUBELED_40 II ECO, 280 mm, cascadable

Item number: 118110-12
EAN: 4260556622774

Order number: 118110-12
Model: TUBELED_40 II
Type: LED surface-mounted luminaire for machines
Illuminant: SMD LED
Power consumption: ~6 W
Lamp luminous flux: 945 lm
Lamp luminous efficiency: 145 lm/W

Light distribution: Light Forming Technology
Light colour: daylight white (5200 - 5700K)

Connected load: 24V DC \pm 10%
Connection (connector): M12 A-type encoded

Degree of protection: IP67/IP69K
Class of protection: III

Glare-free diffused safety glass
Beam angle (optics): 100°

Operating temperature: -30... +70 °C
Colour rendering (Ra): > 85

Lamps lifetime: > 60,000 h
Housing material: aluminium

Cover material: safety glass, 4 mm
Height [B] x Width [C]: 29 mm x 40 mm

Length [A]: 280 mm
Weight (net): 360 g

Gross weight: 550 g
Risk group (DIN EN 62471): free group

Marking: CE, UKCA, ETL Listed (5003526)
Mounting accessories: optional

Dimmable: via optional accessory
Made in: Germany

Feature: resistant to high temperatures, cascadable

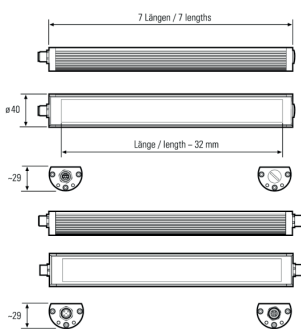
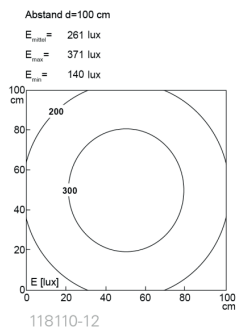

Several luminaires can be interlinked electrically. Electrical through-wiring (cascadable) up to max. 8 A DC at ta max. +30 °C (7 A DC at ta max. +40 °C)
Lamps lifetime in operation hours (L80/B10)